

NEW PRODUCT  
PROMOTION **2023**

柳条系列

# WICKER SERIES

Has applied for a patent, all rights reserved.

AGO  
PLASTIC RATTAN  
SINCE 1999

# WICKER SERIES

## 柳条系列

The biggest feature of the wicker series is the realistic and disordered particle nodules, with the background color of natural simulation, it is extremely close to real wicker. The craftsmanship of the big and small rattan makes the product achieve a visual effect of fake and real.

The series has a total of 5 colors and two effects.

The yellow imitation wicker effect is closer to wicker, And other gray, brown imitation wicker is to imitate the effect of weathered wood.

And another effect - the lime effect, it has an aged effect, matte and natural, like a layer of limewater on the rattan.



Has applied for a patent, all rights reserved.

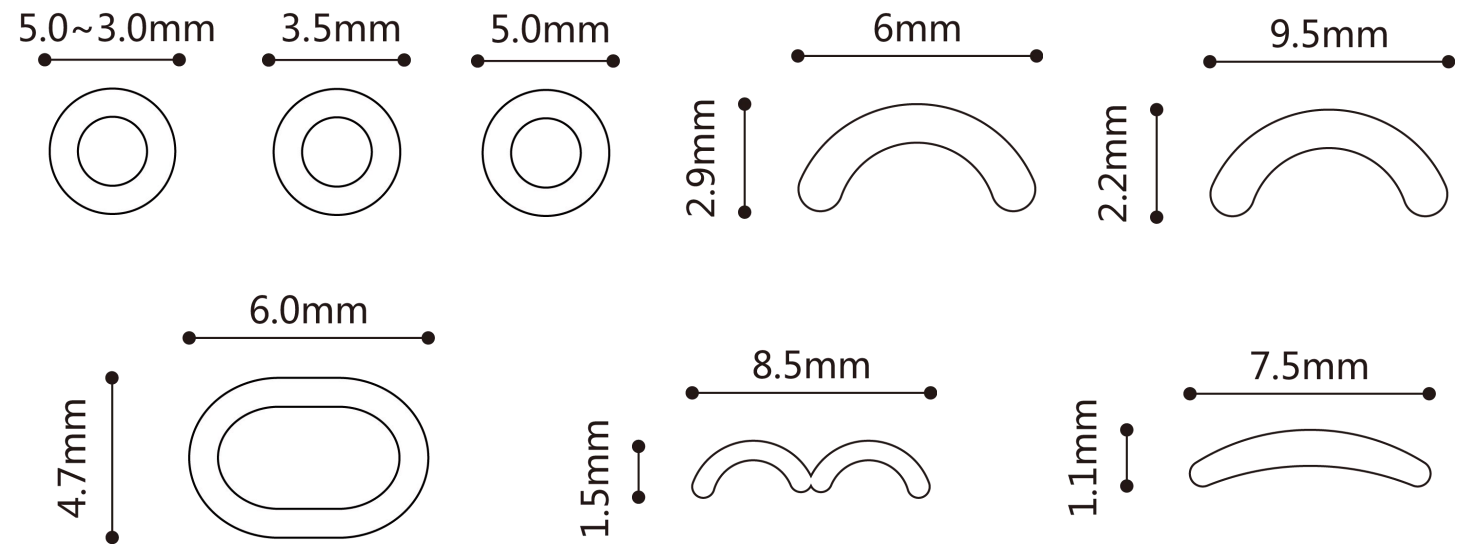



40-A3  $\Phi$ 5.0

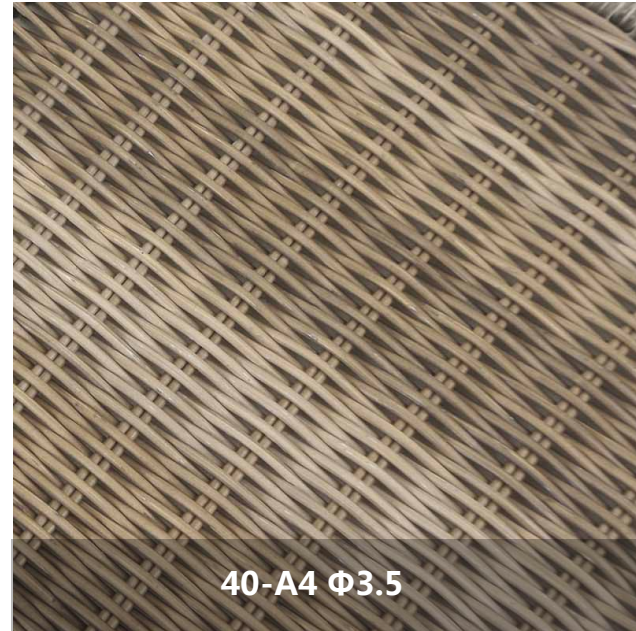

40-A4  $\Phi$ 3.5

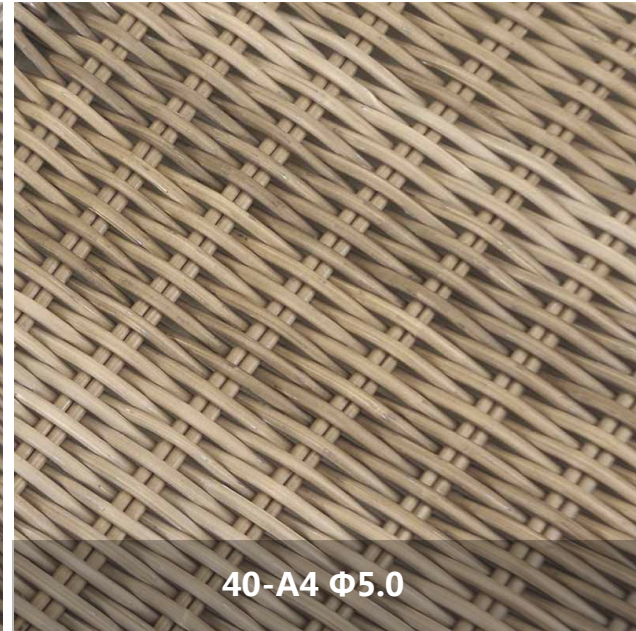

40-A4  $\Phi$ 5.0

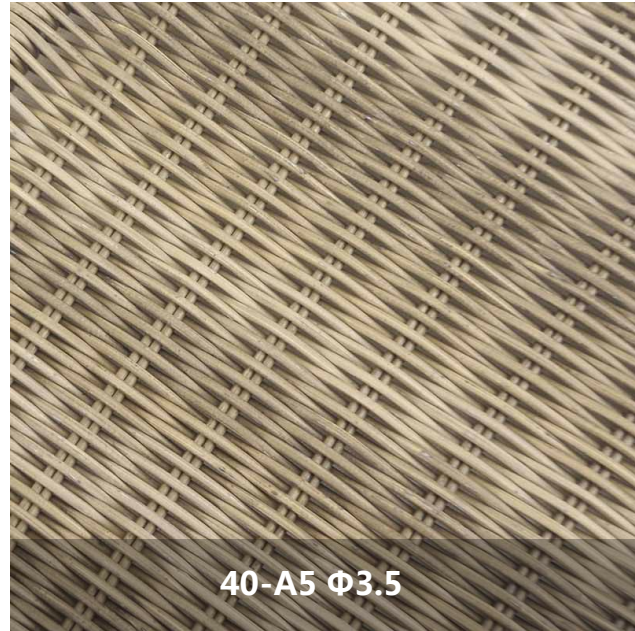

40-A5  $\Phi$ 3.5

## COLORFUL SERIES

Has applied for a patent, all rights reserved. 柳条系列

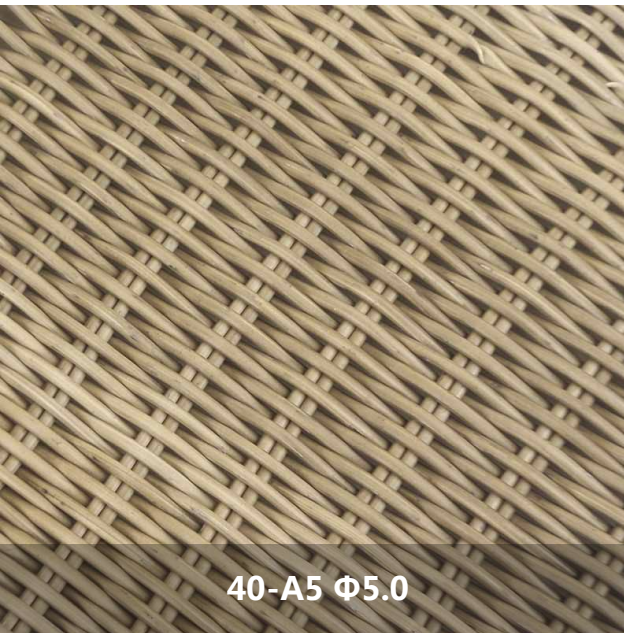

40-A5  $\Phi$ 5.0

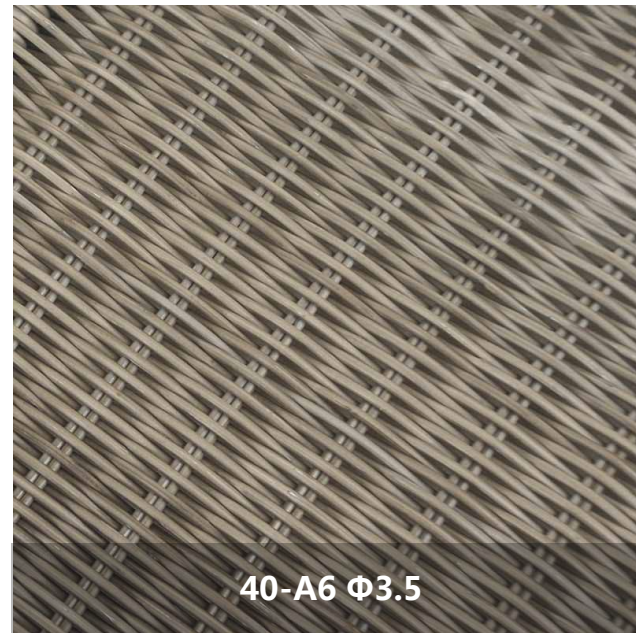

40-A6  $\Phi$ 3.5

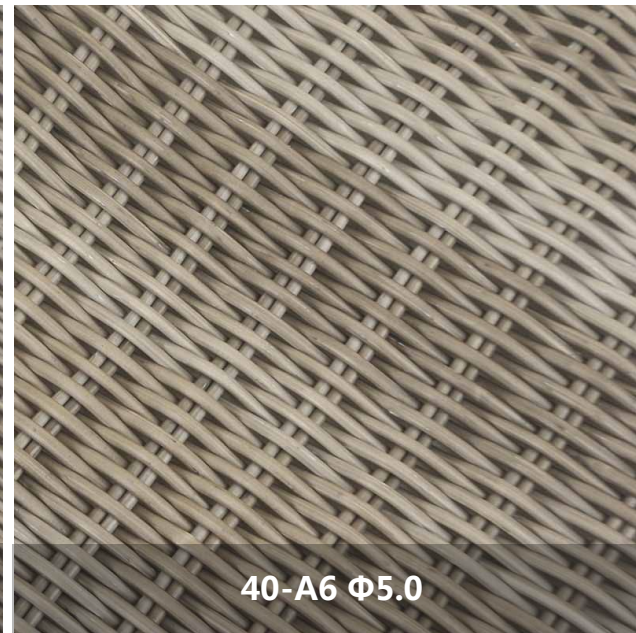

40-A6  $\Phi$ 5.0

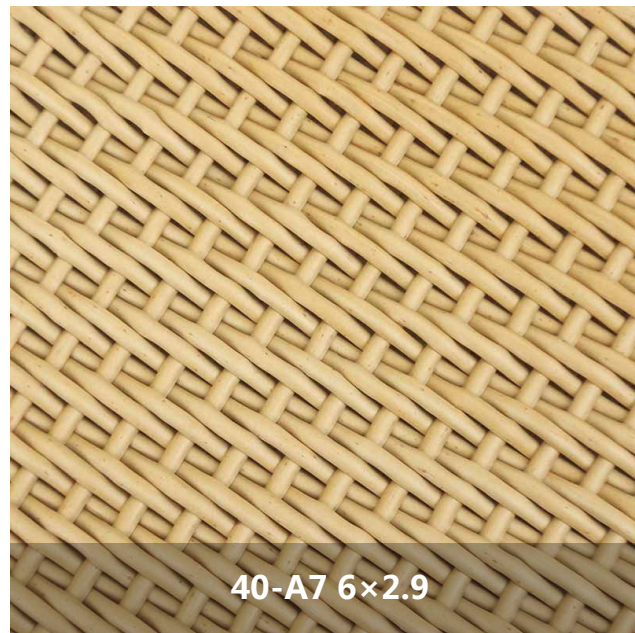

40-A7 6 $\times$ 2.9

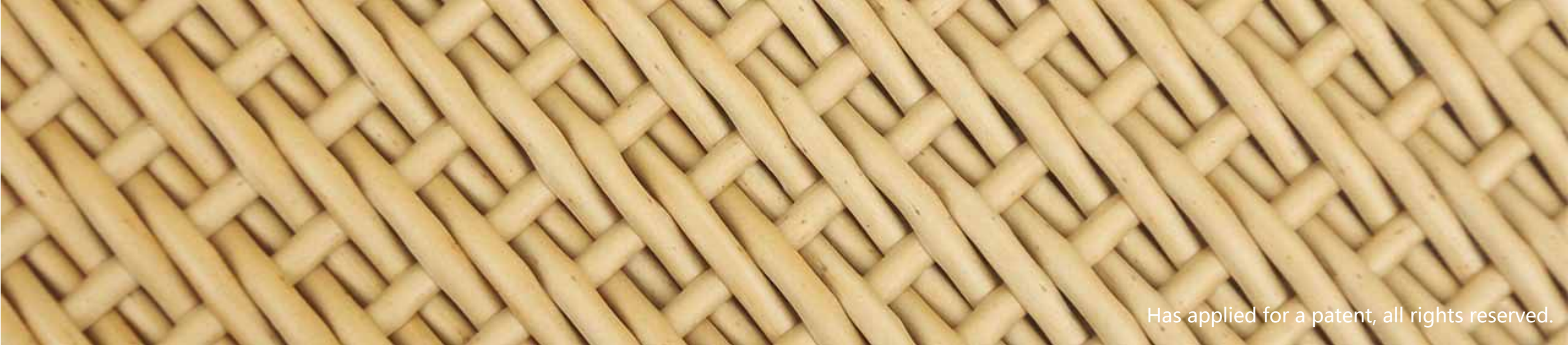

Has applied for a patent, all rights reserved.

# WICKER SERIES

柳条系列

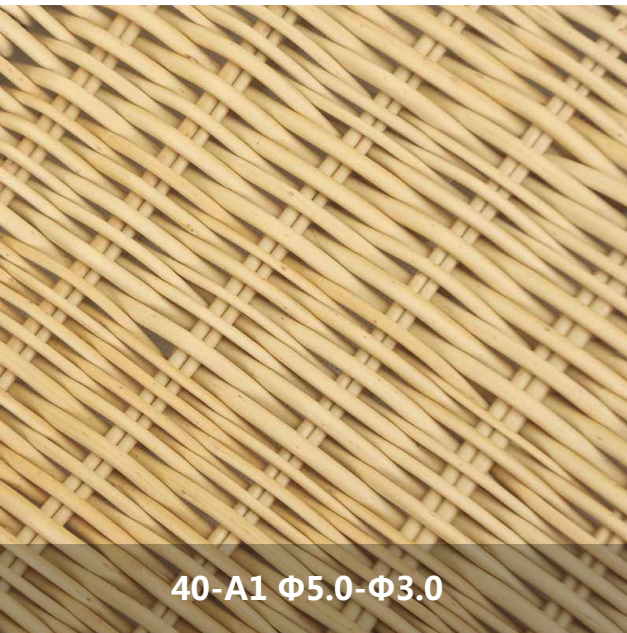

40-A1  $\Phi$ 5.0- $\Phi$ 3.0

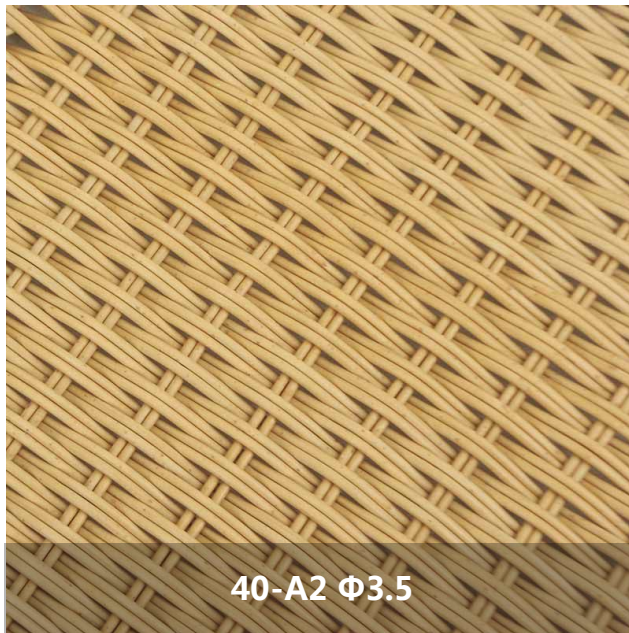

40-A2  $\Phi$ 3.5

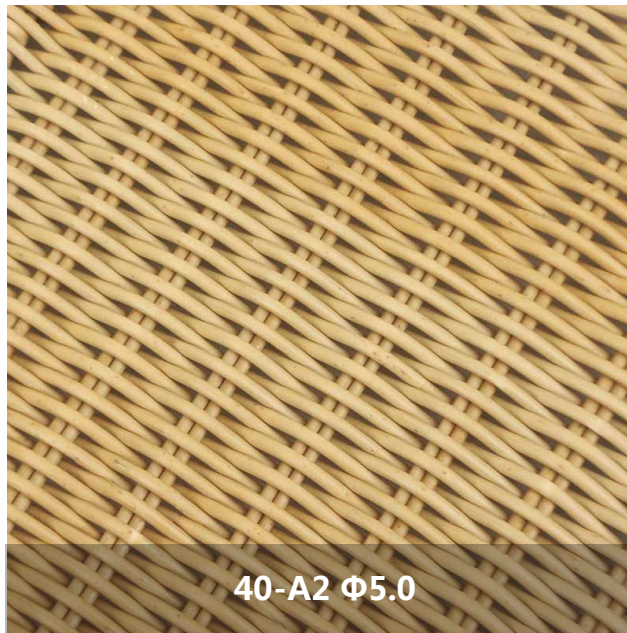

40-A2  $\Phi$ 5.0

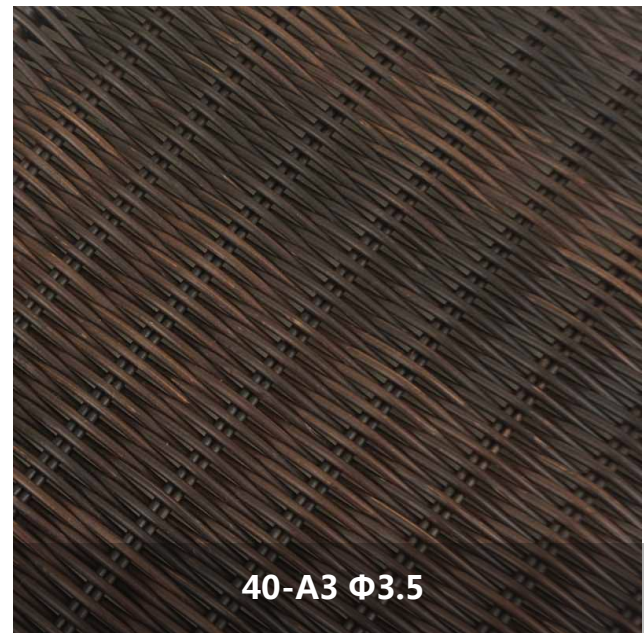

40-A3  $\Phi$ 3.5

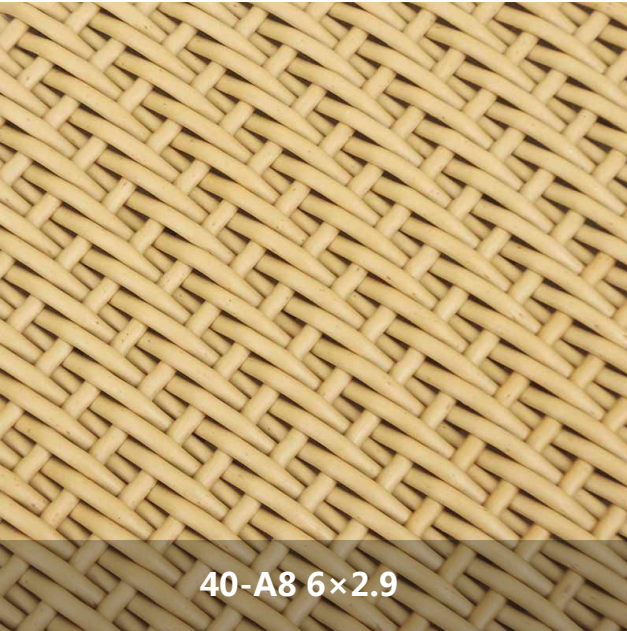

40-A8 6×2.9

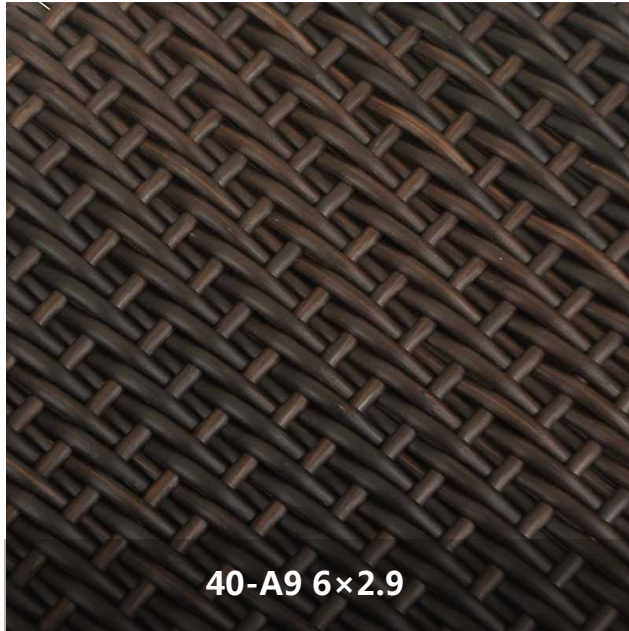

40-A9 6×2.9

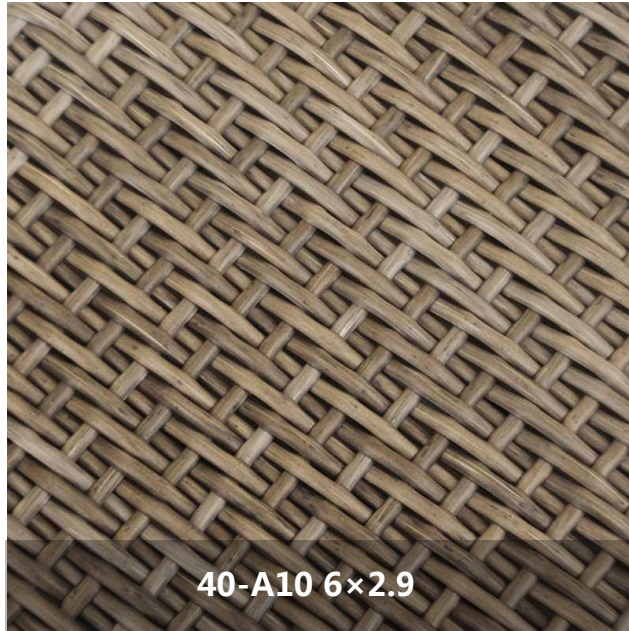

40-A10 6×2.9

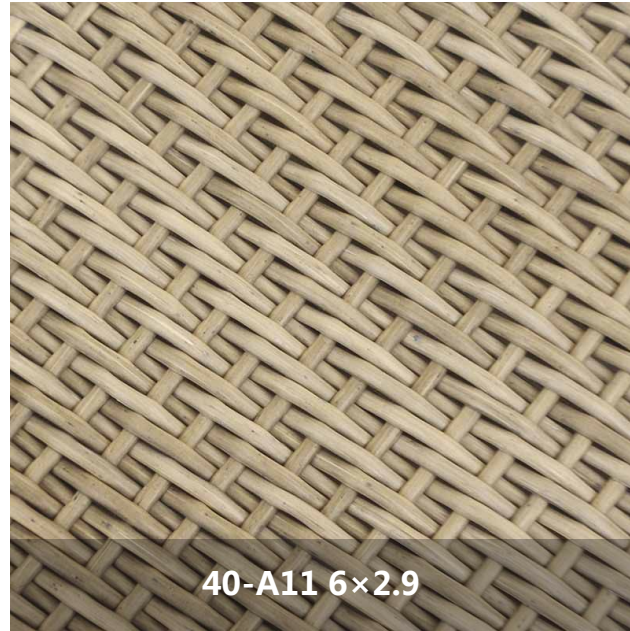

40-A11 6×2.9

# WICKER SERIES

柳条系列

Has applied for a patent, all rights reserved.

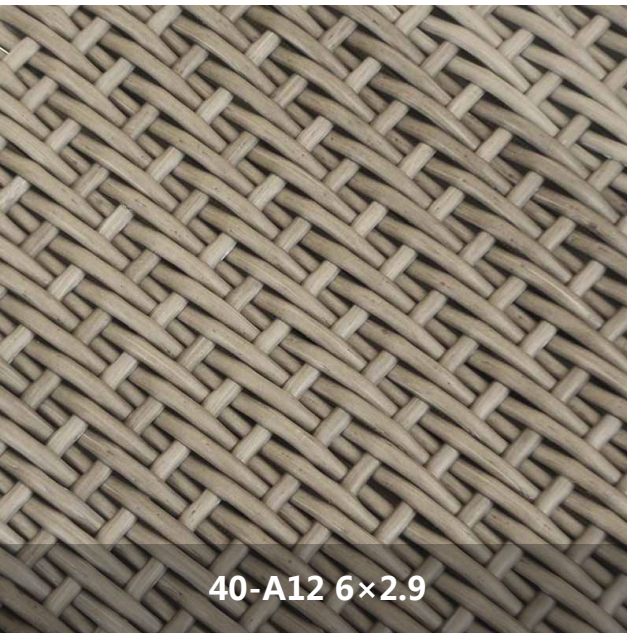

40-A12 6×2.9

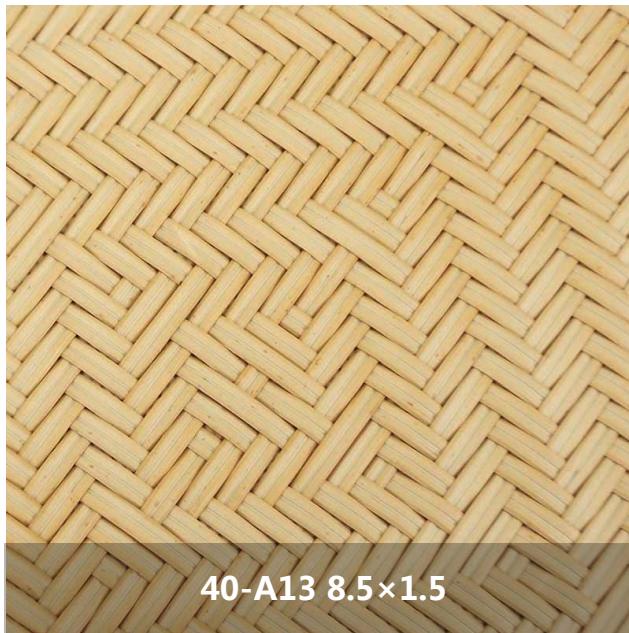

40-A13 8.5×1.5

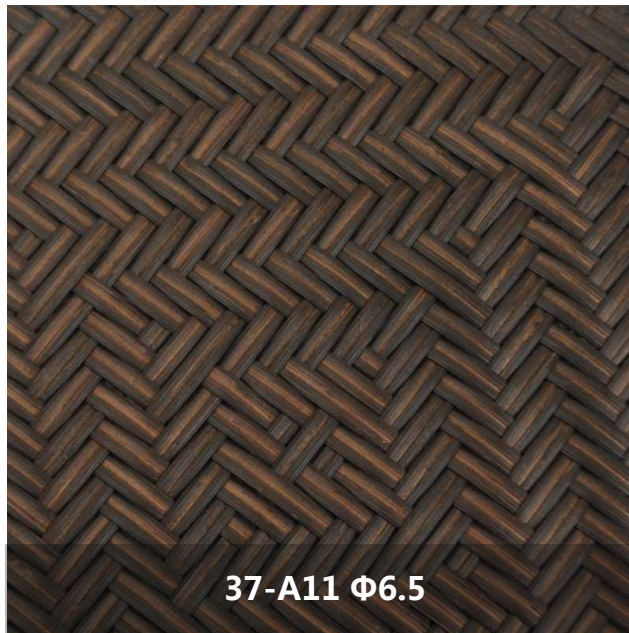

37-A11 Φ6.5

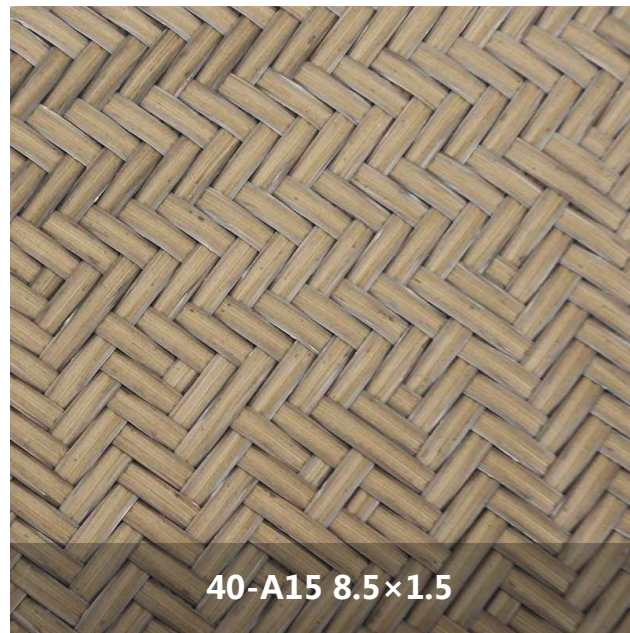

40-A15 8.5×1.5



40-A16 8.5×1.5



40-A17 8.5×1.5

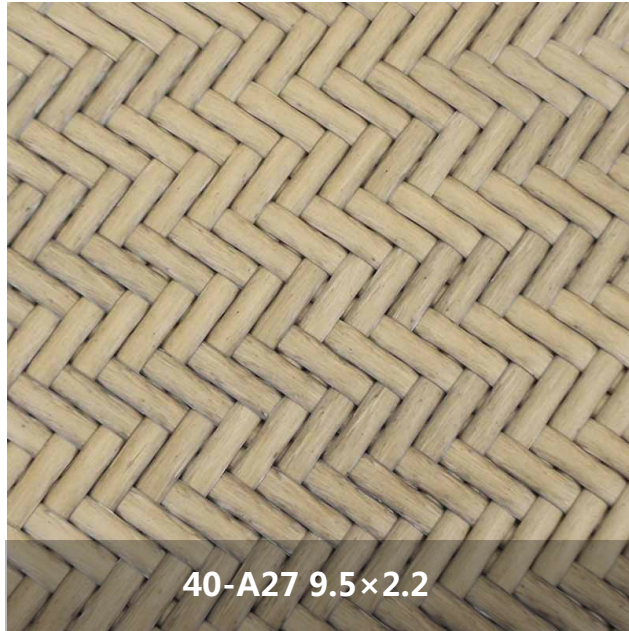

40-A27 9.5×2.2

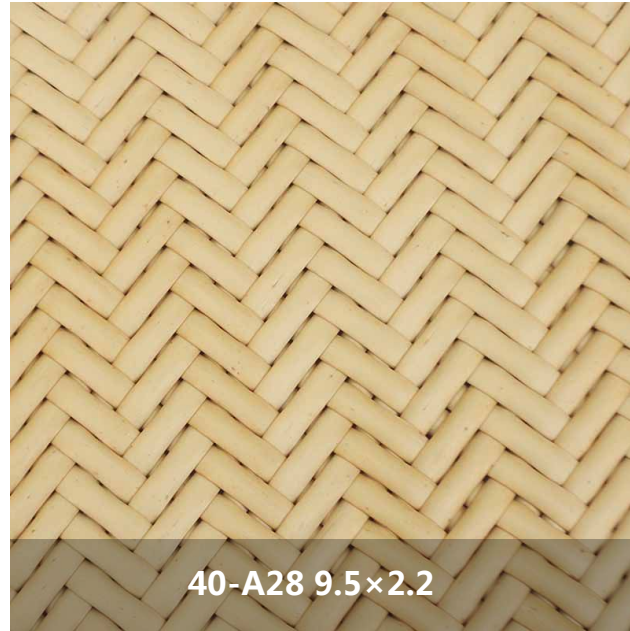

40-A28 9.5×2.2

# WICKER SERIES

Has applied for a patent, all rights reserved.

柳条系列

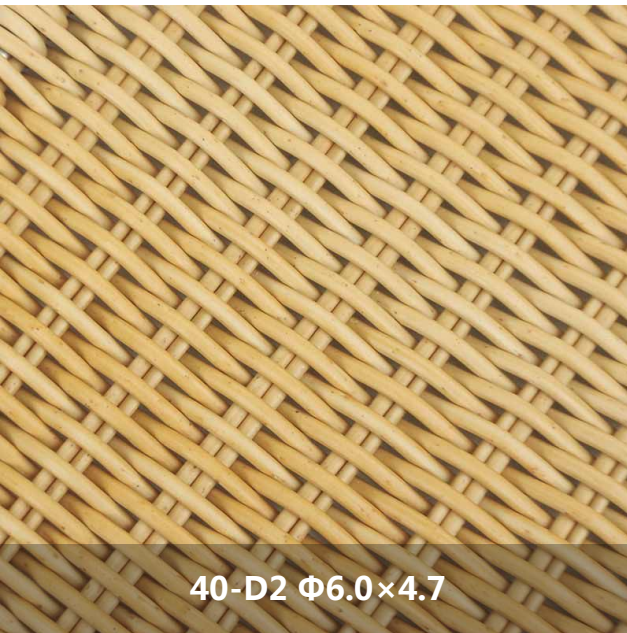

40-D2  $\Phi 6.0 \times 4.7$

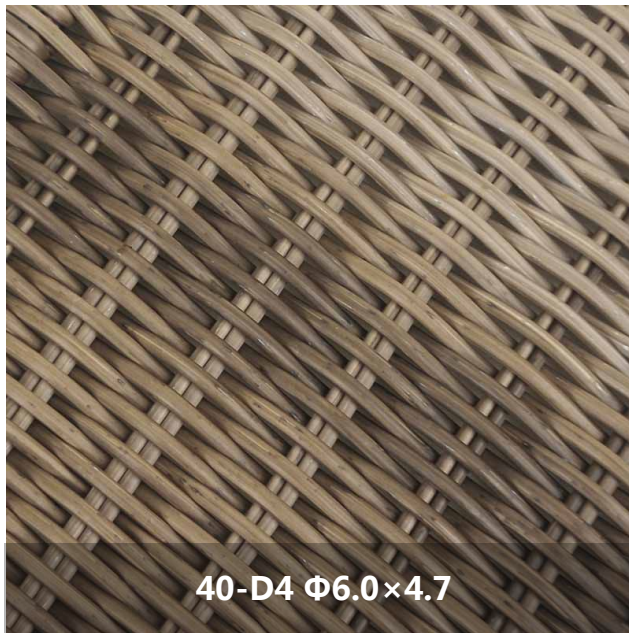

40-D4  $\Phi 6.0 \times 4.7$

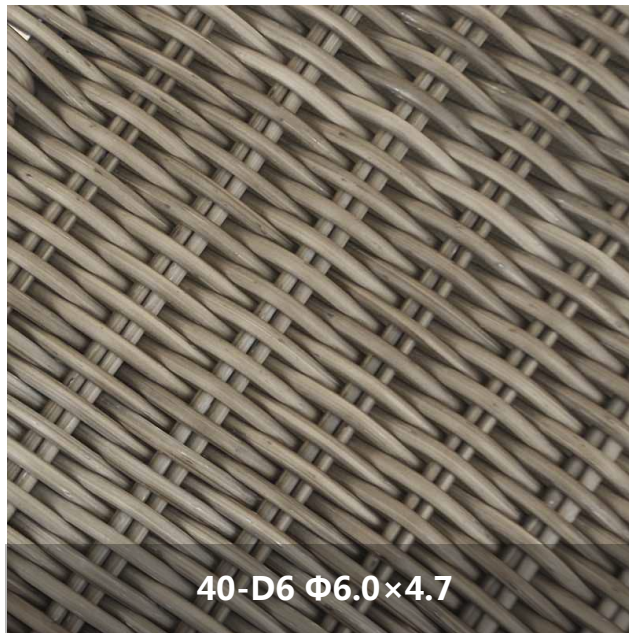

40-D6  $\Phi 6.0 \times 4.7$

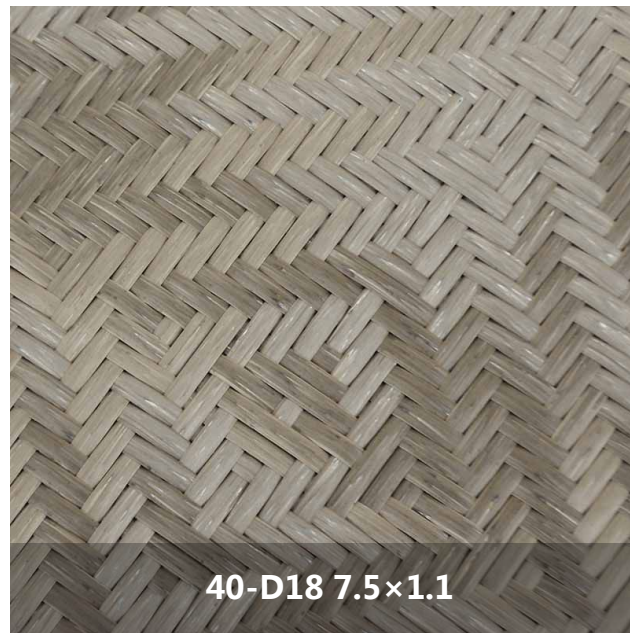

40-D18 7.5×1.1



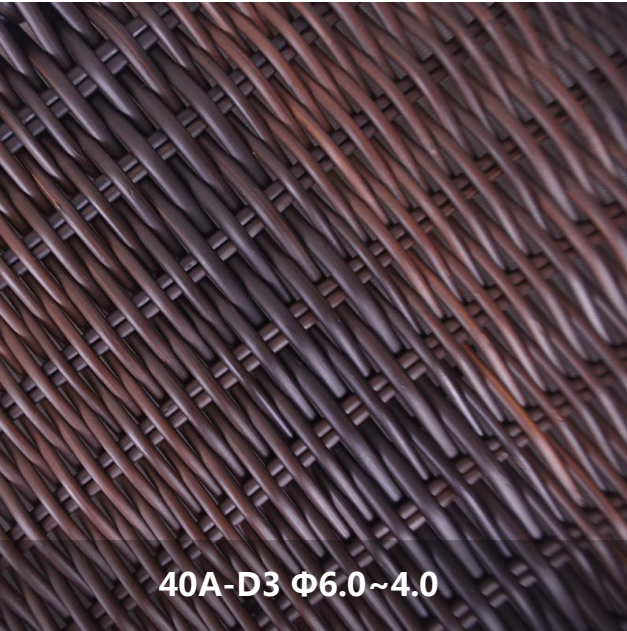

40A-D3  $\Phi$ 6.0~4.0

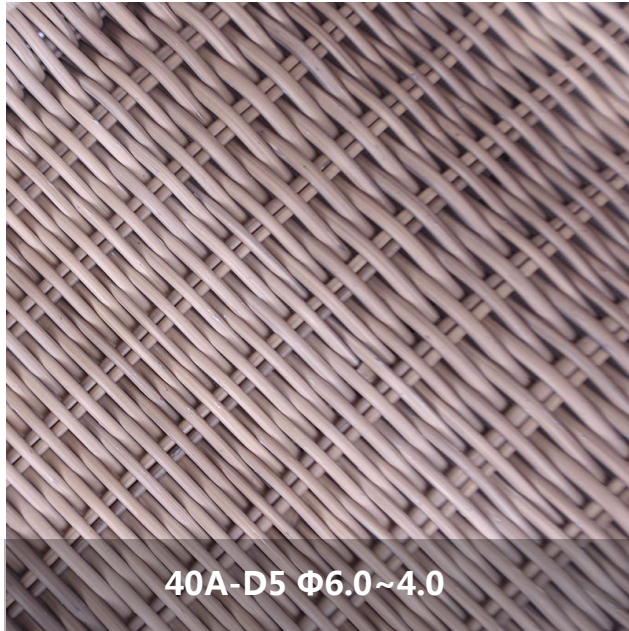

40A-D5  $\Phi$ 6.0~4.0

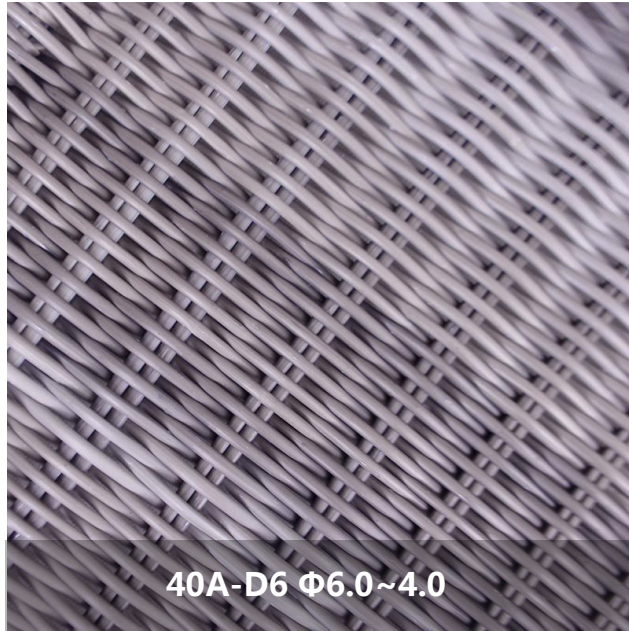

40A-D6  $\Phi$ 6.0~4.0

# WICKER SERIES

柳条系列



Has applied for a patent, all rights reserved.

柳条系列 - 石灰效果

# WICKER SERIES - LIME EFFECT

Has applied for a patent, all rights reserved.

**AGO**  
PLASTIC RATTAN  
SINCE 1999



Has applied for a patent, all rights reserved.

# WICKER SERIES - LIME EFFECT

柳条系列



40-A19  $\Phi$ 5.0

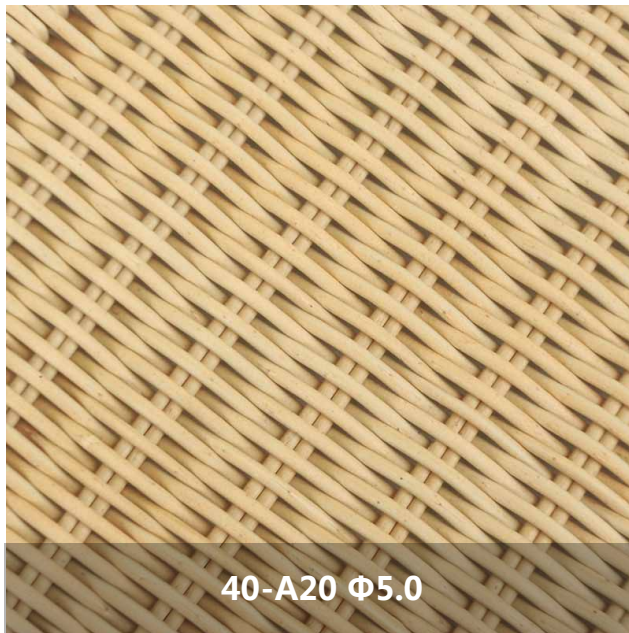

40-A20  $\Phi$ 5.0

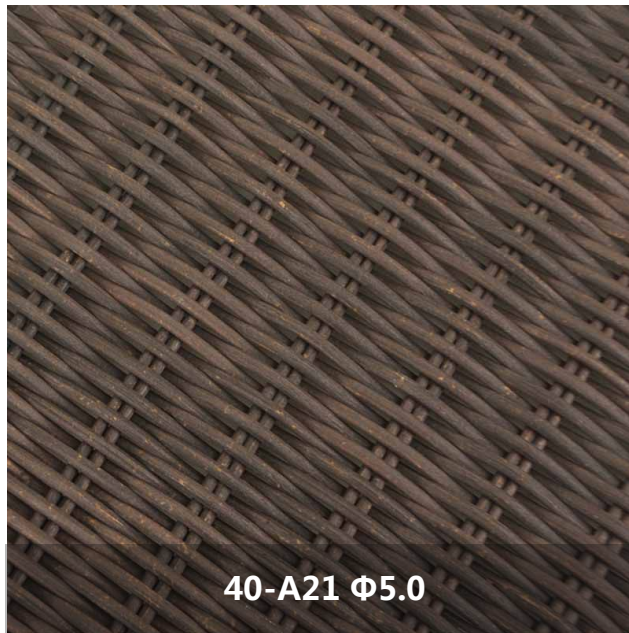

40-A21  $\Phi$ 5.0

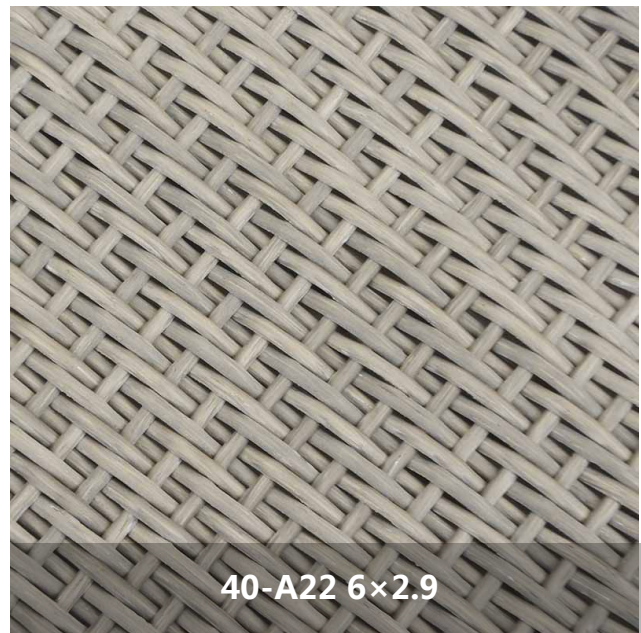

40-A22 6×2.9

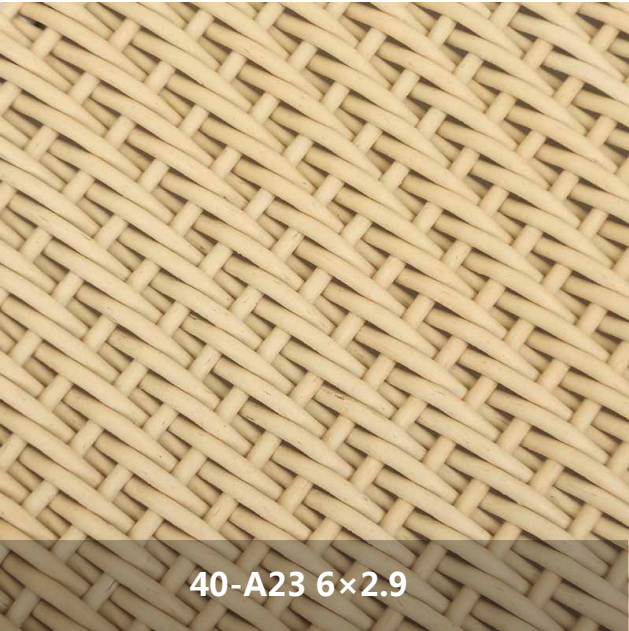

40-A23 6×2.9

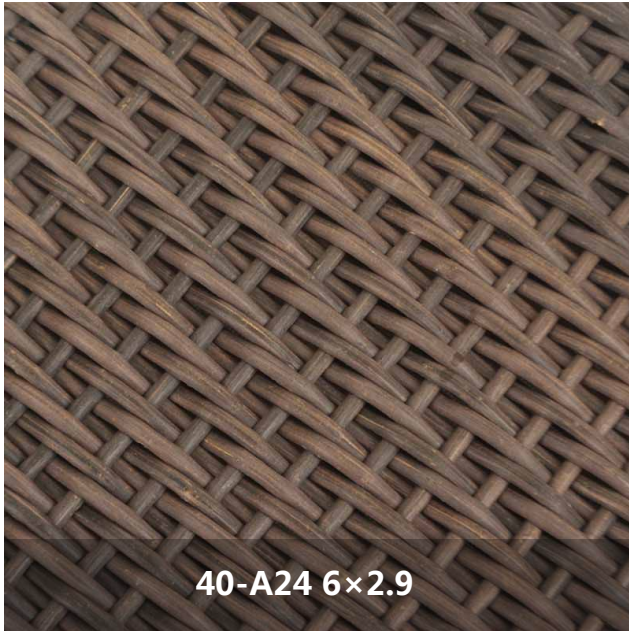

40-A24 6×2.9

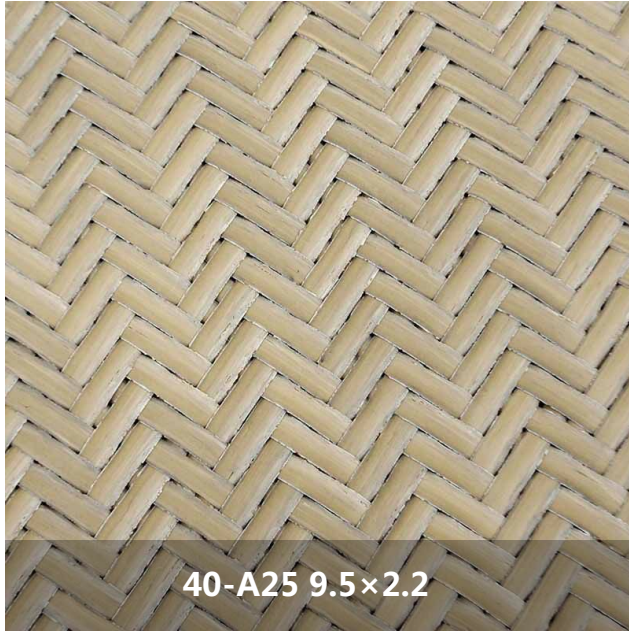

40-A25 9.5×2.2

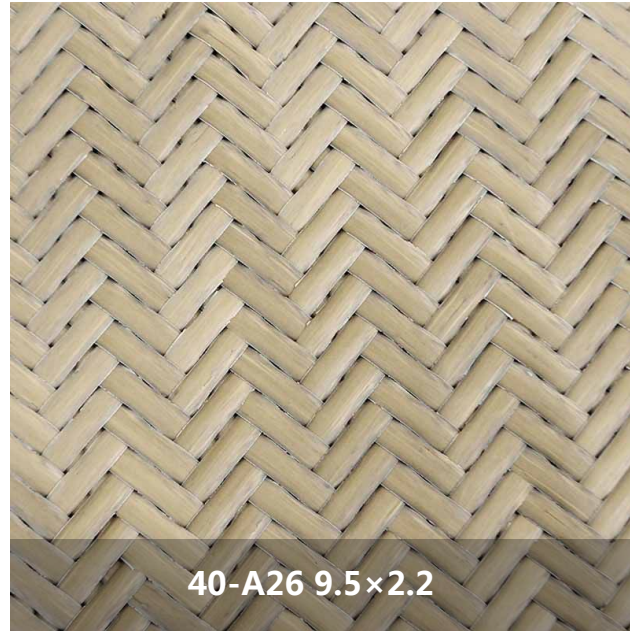

40-A26 9.5×2.2

## WICKER SERIES - LIME EFFECT

柳条系列



Has applied for a patent, all rights reserved.

# THANKS

**AGO**  
PLASTIC RATTAN  
SINCE 1999

[www.china-ago.com](http://www.china-ago.com)

佛山市艺骏雄塑胶仿藤有限公司  
AGO PLASTIC RATTAN CO.,LTD.

TEL:86-757-26600661/26600662

FAX:86-757-26322441

