

NEW PRODUCT  
PROMOTION **2020**

皮藤

# LEATHER RATTAN

Has applied for a patent, all rights reserved.

**AGO**  
PLASTIC RATTAN  
SINCE 1999



# LEATHER RATTAN

## 皮藤

Leather fiber is a series of new products that we launched in 2019.

After two years of research and development, this product is AGO's new fourth-generation product. This product is a composite product that combines a variety of materials. Its combination determines the characteristics of the product: good feeling and look like a real leather, soft and tough, strong tensile force, the most importantly it is extremely light.

This product is ideal for weaving modern minimalist products, simple and textured, luxurious and not high-profile.

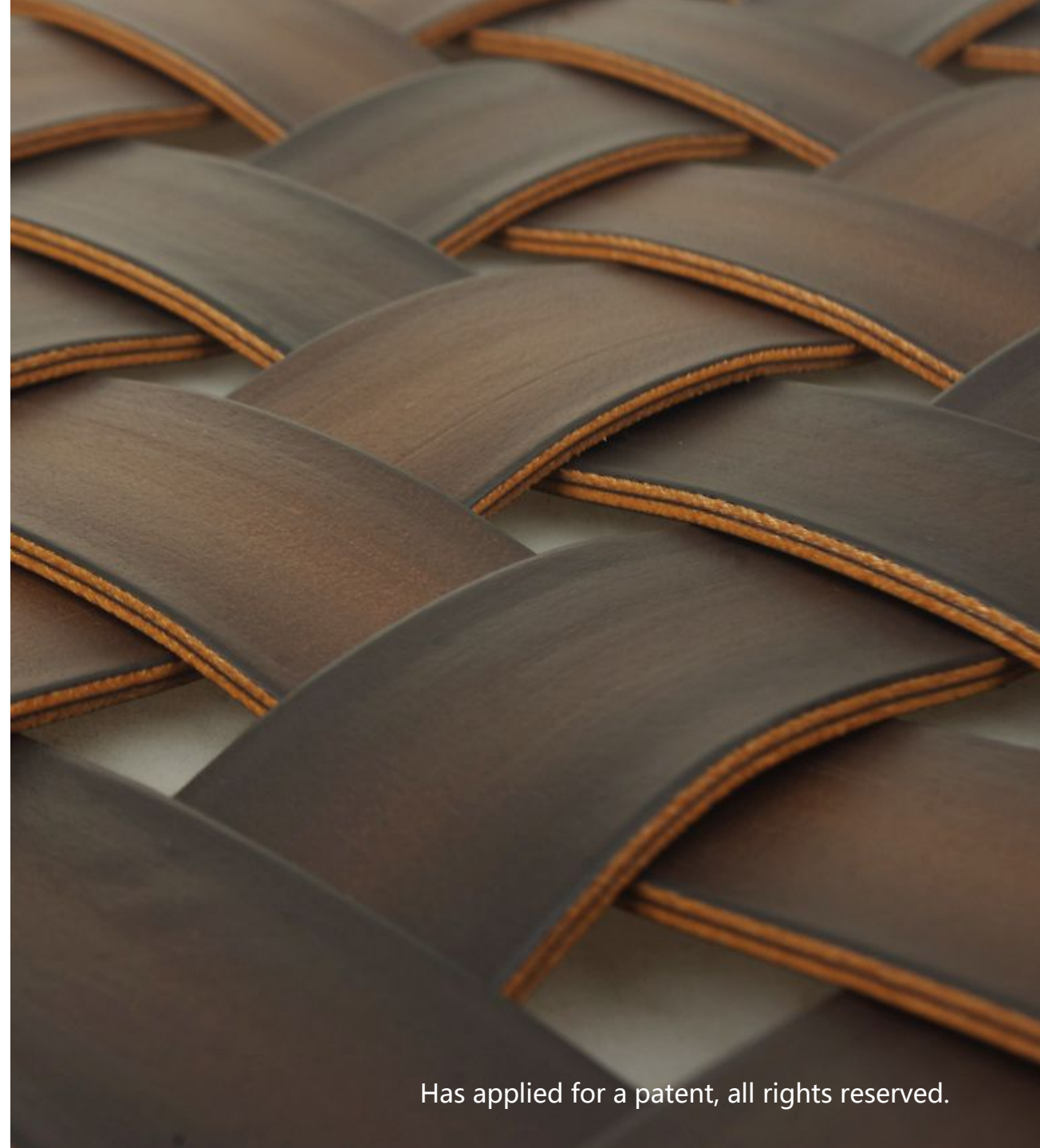

Has applied for a patent, all rights reserved.

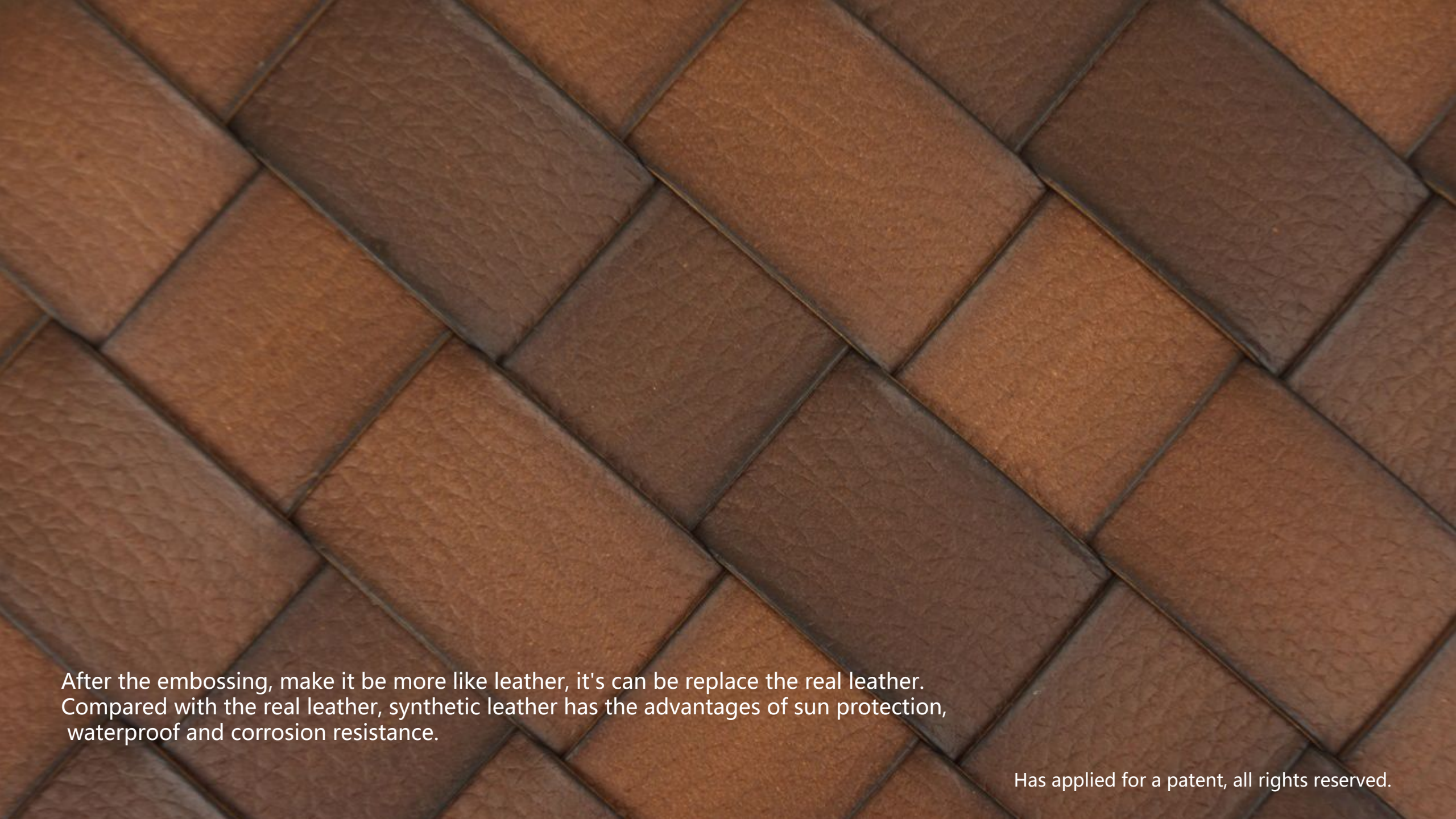

After the embossing, make it be more like leather, it's can be replace the real leather.  
Compared with the real leather, synthetic leather has the advantages of sun protection,  
waterproof and corrosion resistance.

Has applied for a patent, all rights reserved.



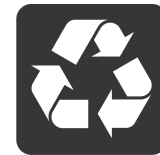
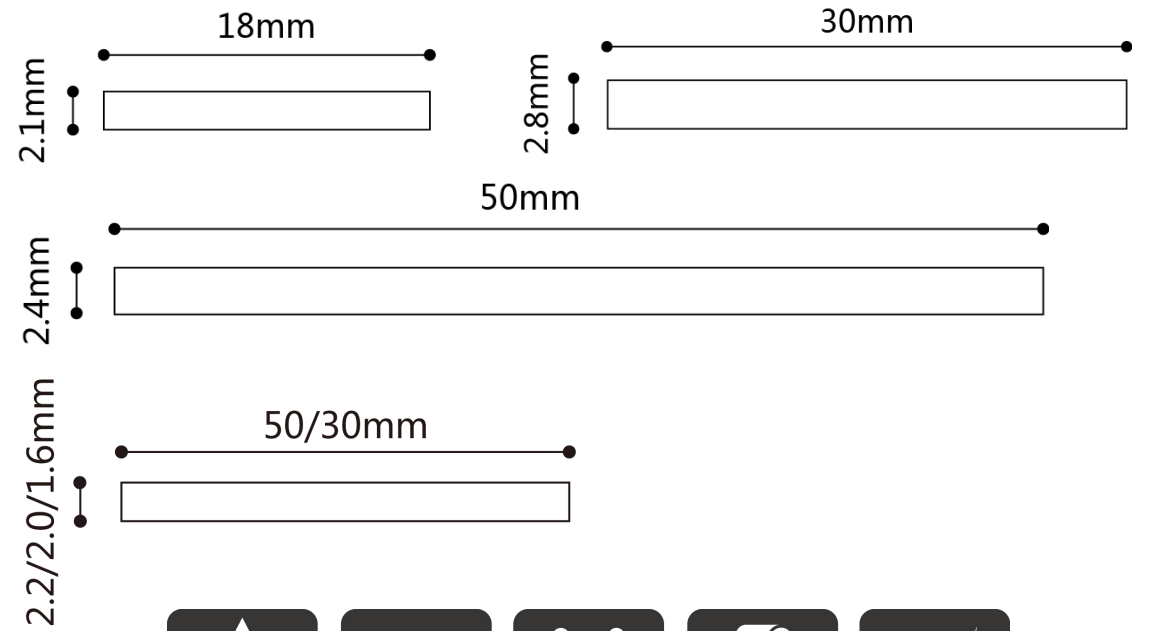





Has applied for a patent, all rights reserved.

# LEATHER RATTAN

皮藤



15-D1 30×2.8

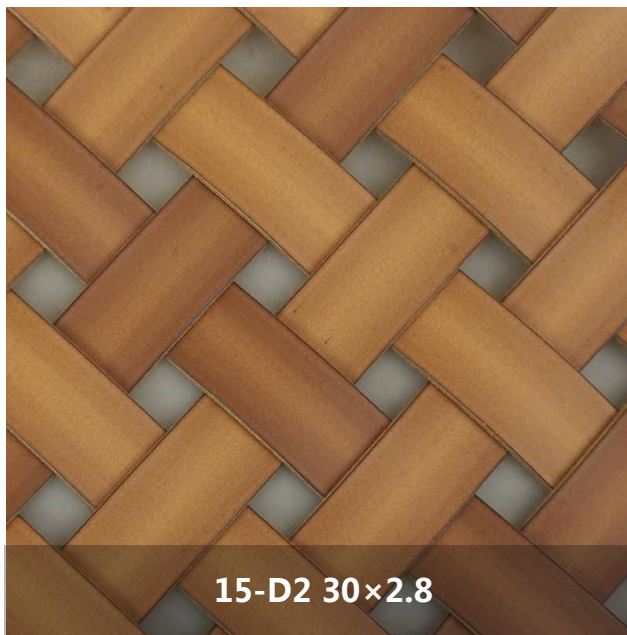

15-D2 30×2.8

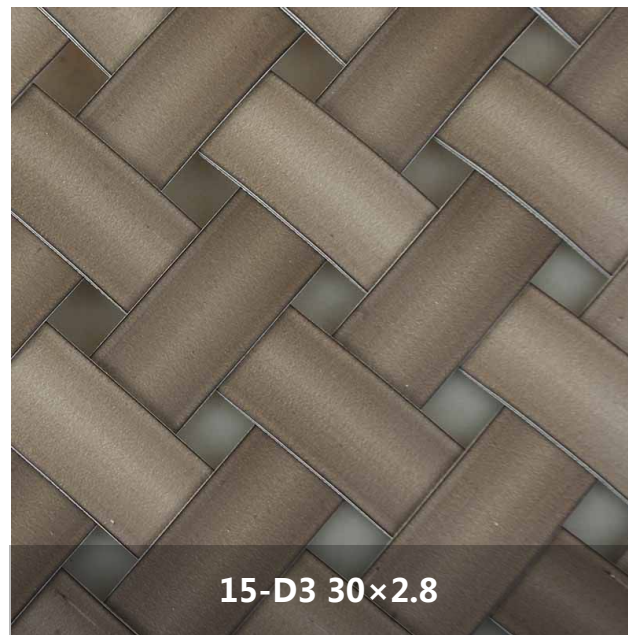

15-D3 30×2.8

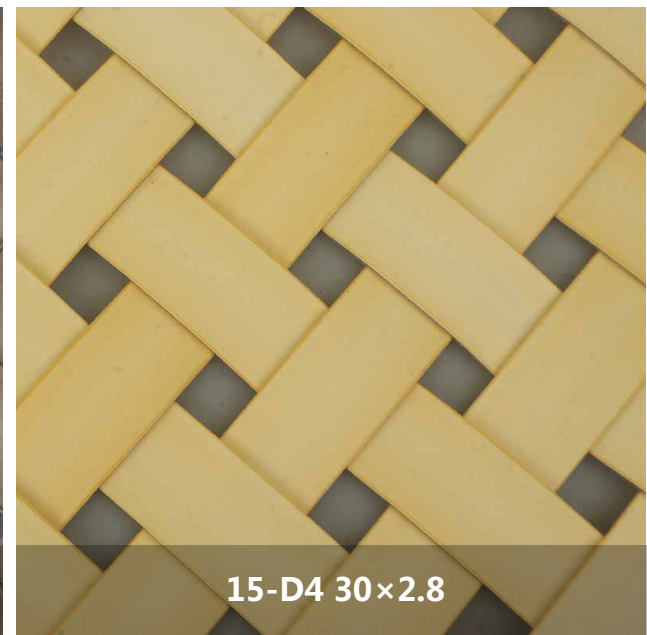

15-D4 30×2.8



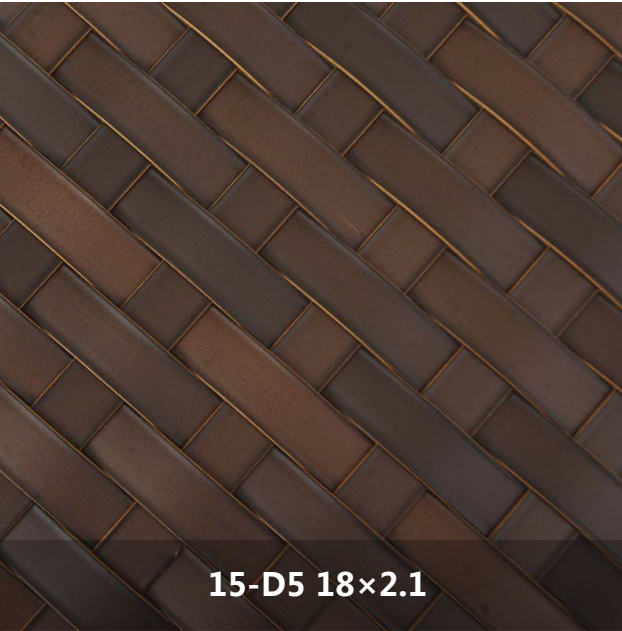

15-D5 18×2.1

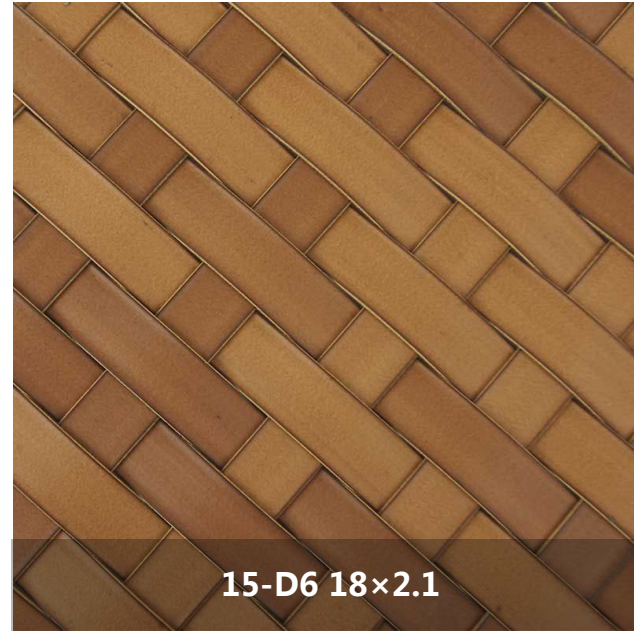

15-D6 18×2.1



15-D7 18×2.1

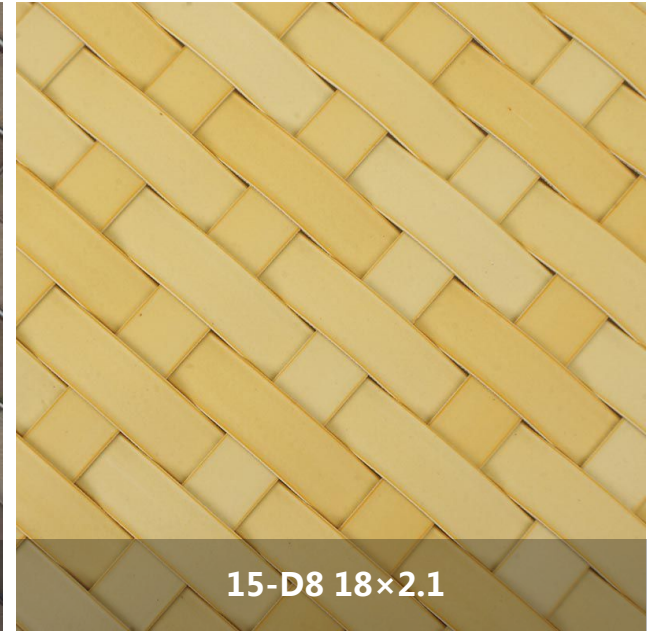

15-D8 18×2.1

# LEATHER RATTAN

皮藤 Has applied for a patent, all rights reserved.

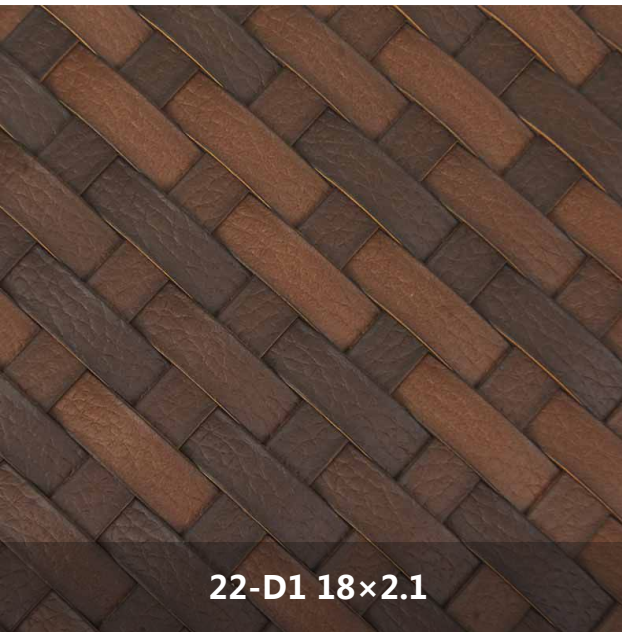

22-D1 18×2.1

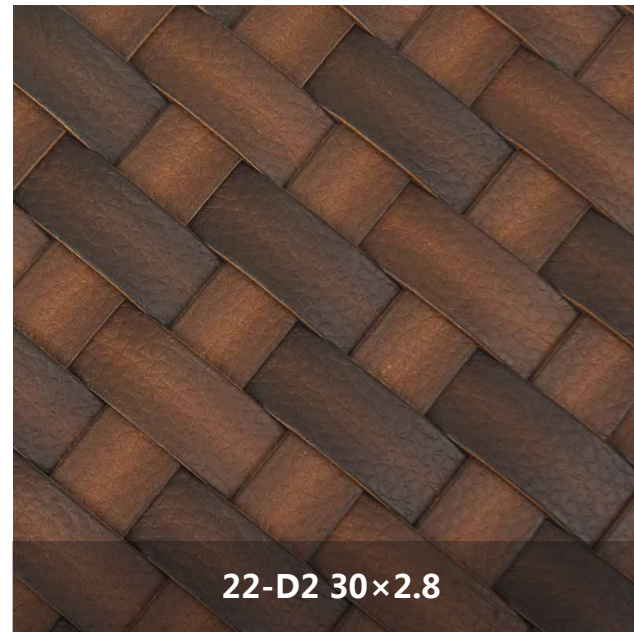

22-D2 30×2.8

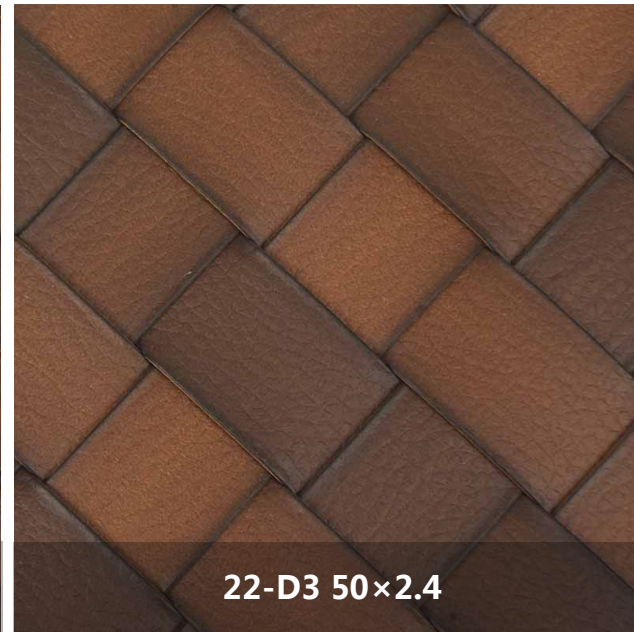

22-D3 50×2.4

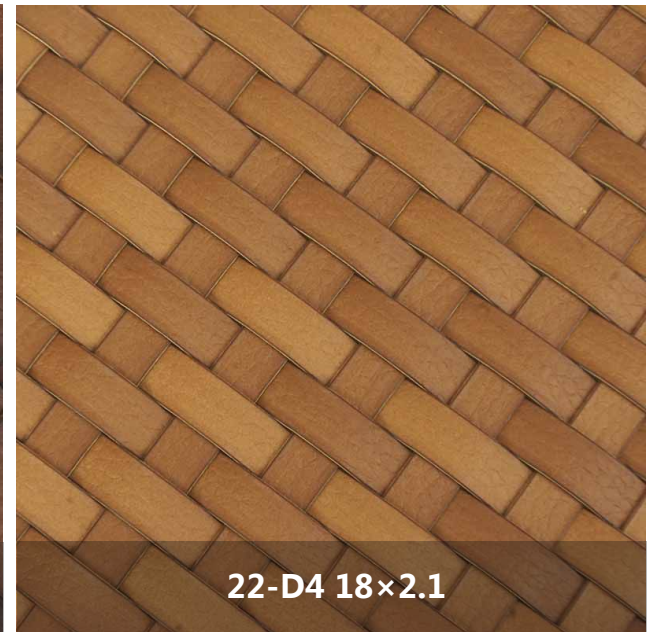

22-D4 18×2.1



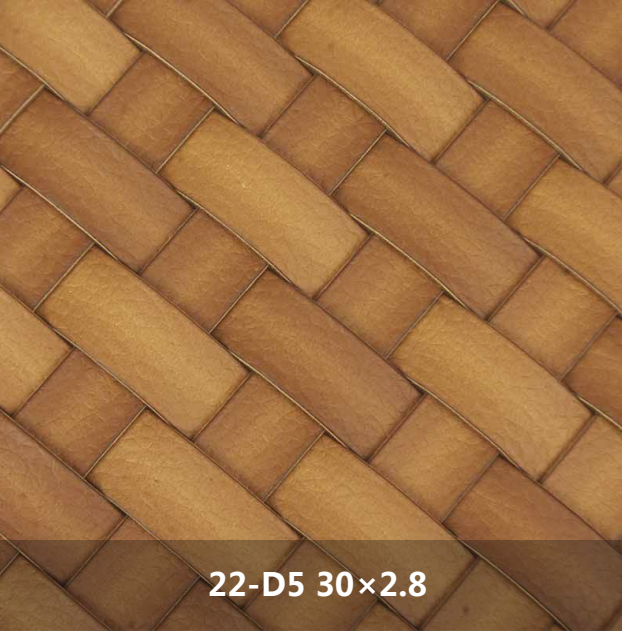

22-D5 30×2.8

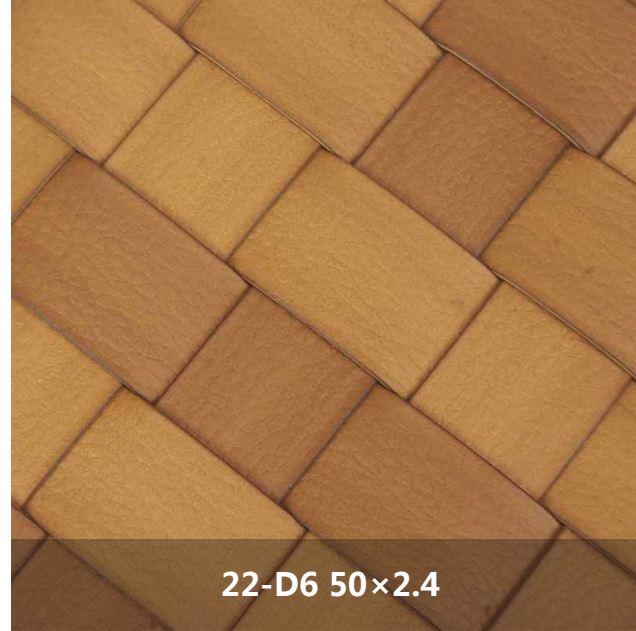

22-D6 50×2.4

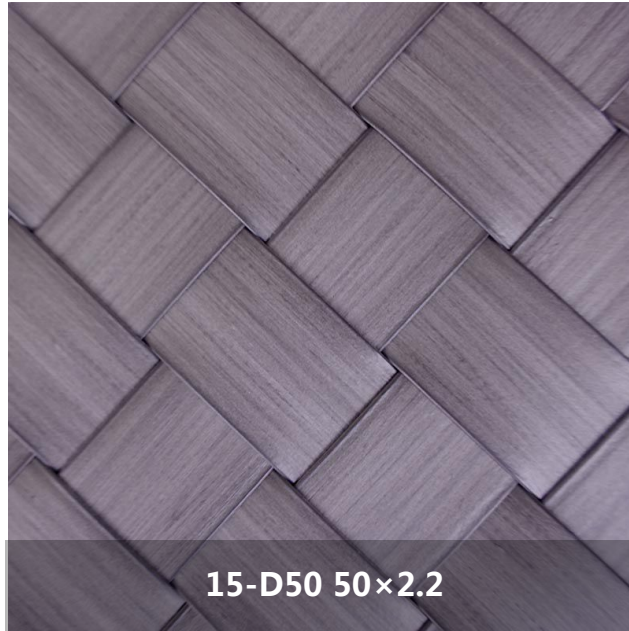

15-D50 50×2.2

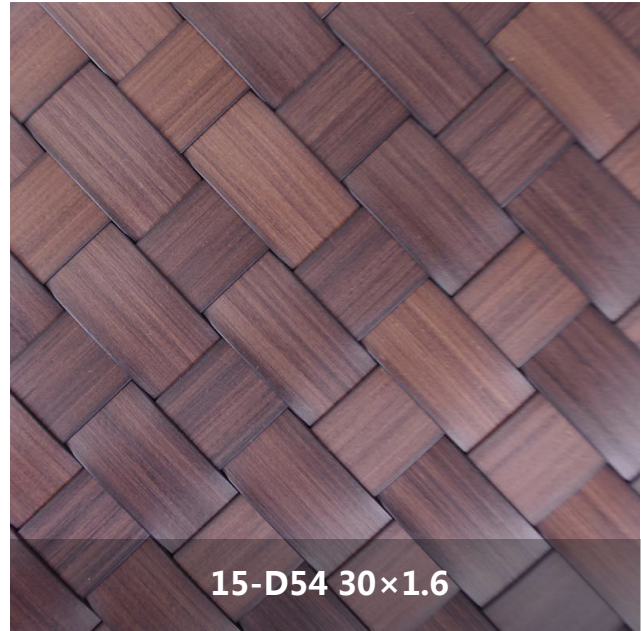

15-D54 30×1.6

# LEATHER

皮藤

# RATTAN

Has applied for a patent, all rights reserved.

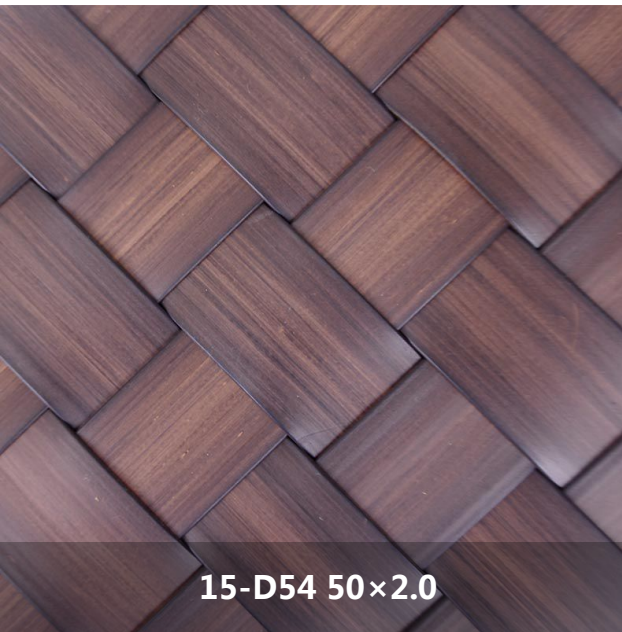

15-D54 50×2.0



15-D55 30×1.6



15-D55 50×2.0



15-D56 30×1.6



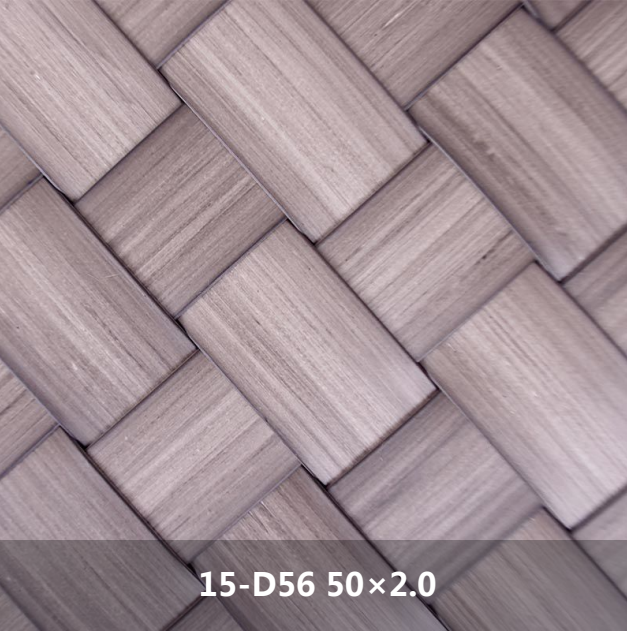

15-D56 50×2.0

# LEATHER RATTAN

皮藤



Has applied for a patent, all rights reserved.



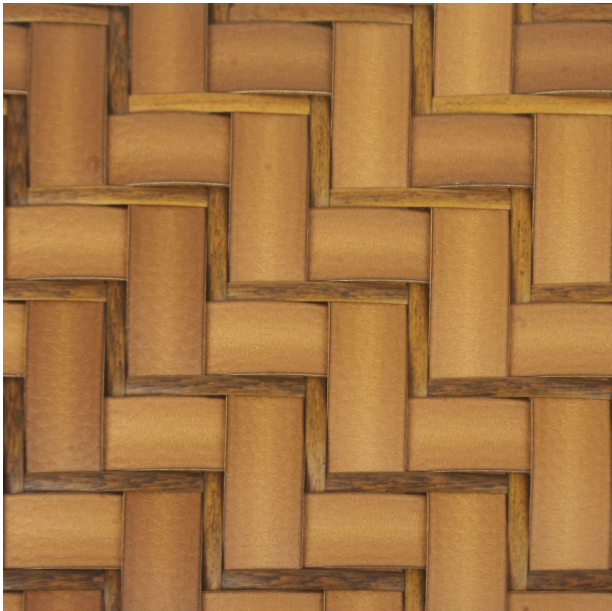

LEATHER RATTAN  
皮藤

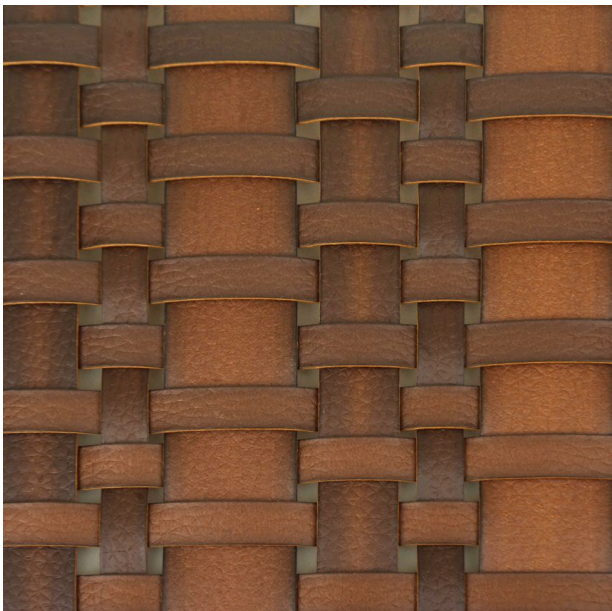

WEAVING REFERENCE

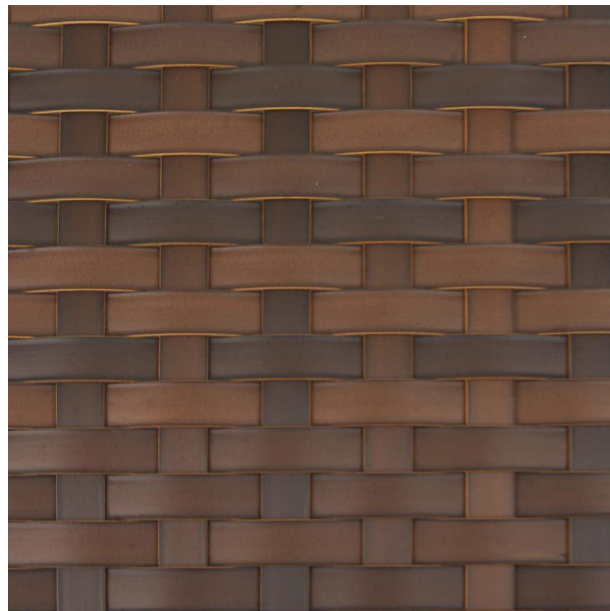



## Reference closing method



End with rivets



Closed in the frame



The seam of the frame is opened, which can be closed in the frame.





Reference use

The image is only a reference to show how to use rattan, copyright belongs to the company of the product, counterfeit consequences.



# THANKS

**AGO**  
PLASTIC RATTAN  
SINCE 1999

[www.china-ago.com](http://www.china-ago.com)

佛山市艺骏雄塑胶仿藤有限公司  
AGO PLASTIC RATTAN CO.,LTD.

TEL:86-757-26600661/26600662

FAX:86-757-26322441

