

2018

产品介绍

PRODUCT INTRODUCTION

THE MAGIC II - O

魔叶 II 代 (O)

专利产品，仿冒必究。

AGO
PLASTIC RATTAN
SINCE 1999

魔叶 II 代 (O)

THE MAGIC II - O

魔叶II代产品是艺骏雄2018年的主推产品。

在魔叶I代产品获得成功的基础上，研发人员对其进行了工艺上的改进，令产品的手感更舒适，颜色更加极致自然。

将魔叶I型产品进行后加工，卷曲成为圆形藤，这在整个仿藤市场上是一个创举。空心的圆藤，大大减轻了藤的重量，从而降低了编织的材料成本。



专利产品，仿冒必究。

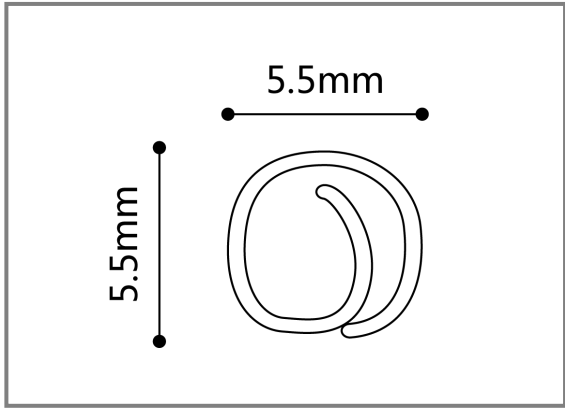



专利产品，仿冒必究。

魔叶 II 代 (O)

THE MAGIC II - O



11-D2 Φ5.5

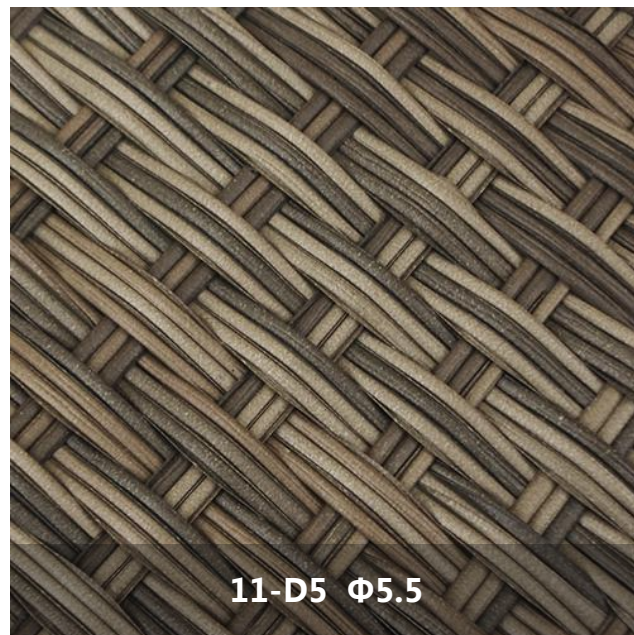

11-D5 Φ5.5

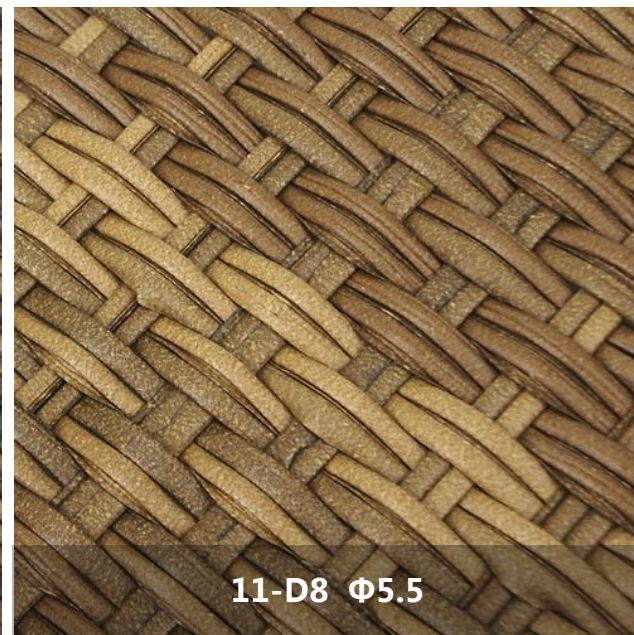

11-D8 Φ5.5

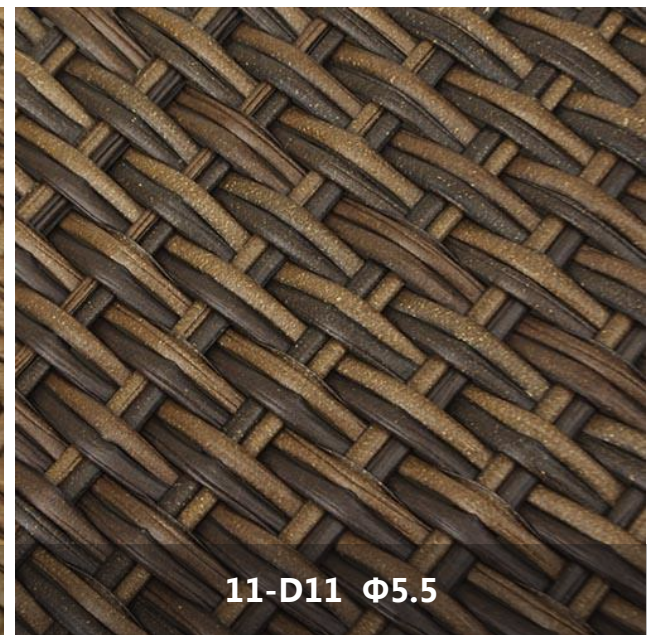

11-D11 Φ5.5



11-D14 Φ 5.5

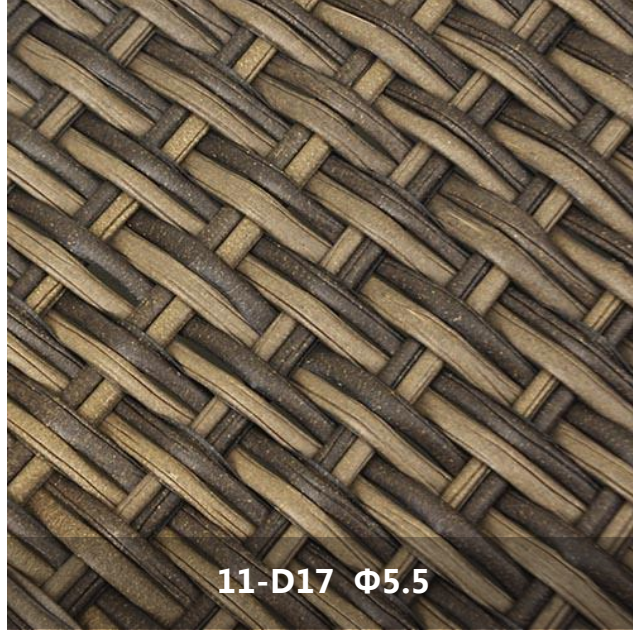

11-D17 Φ 5.5

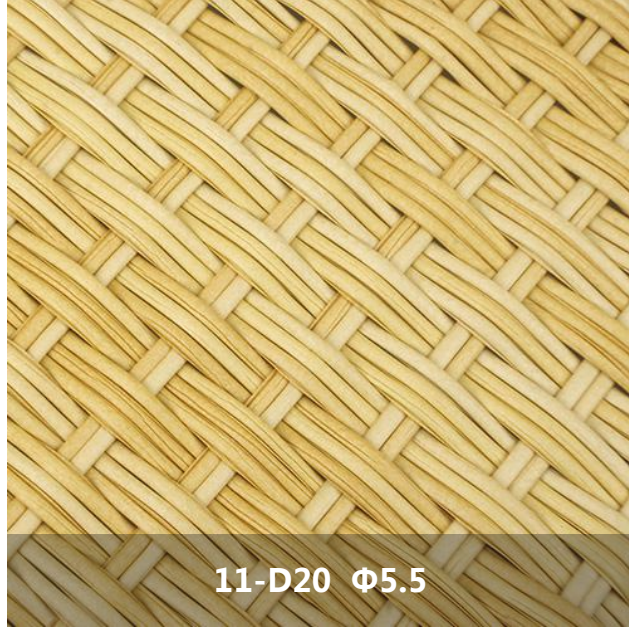

11-D20 Φ 5.5



11-D24 Φ 5.5

魔叶 II 代 (O)

THE MAGIC II - O



11-D27 Φ 5.5

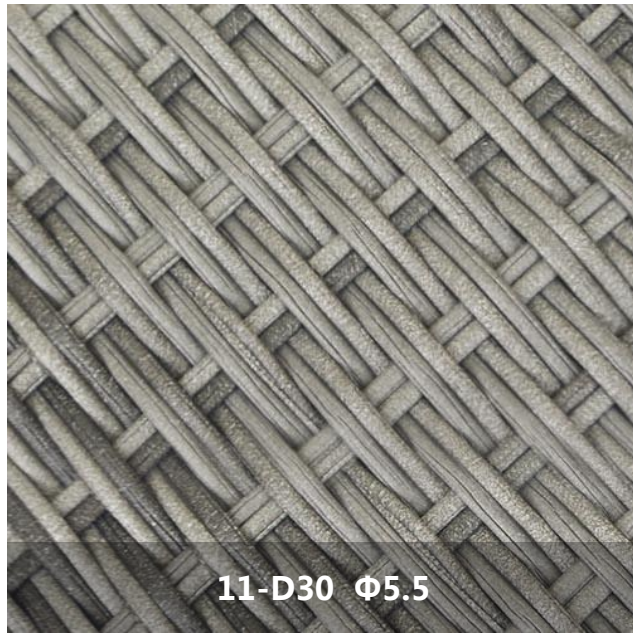

11-D30 Φ 5.5

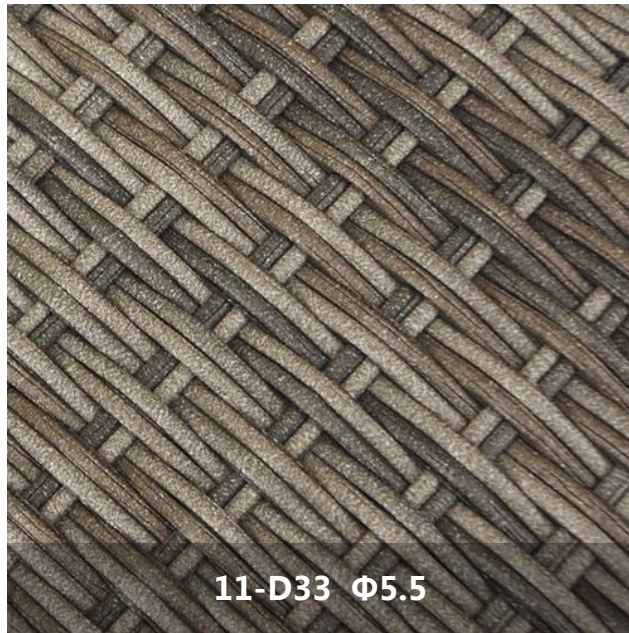

11-D33 Φ 5.5

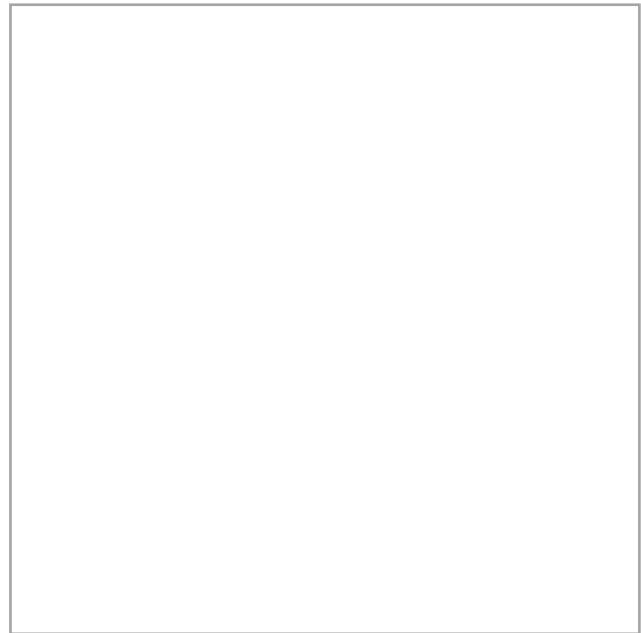

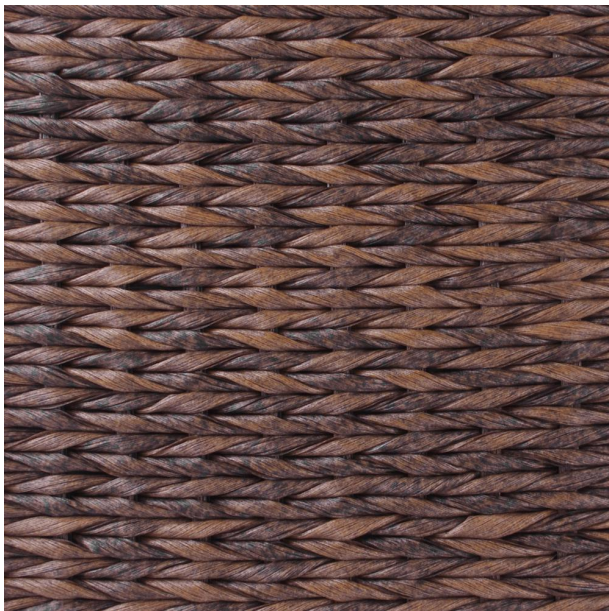
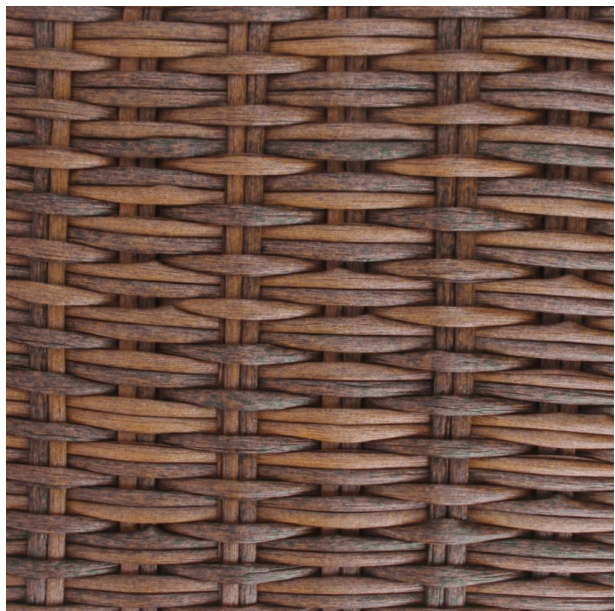

魔叶 II 代 (O)
THE MAGIC II - O



推荐编织方法

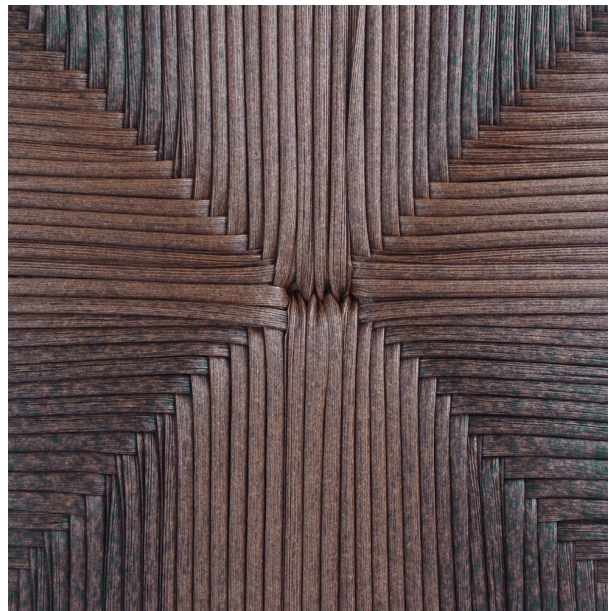



参考案例

镂空编织与密编结合，既丰富高档，也能节省材料成本，空心的发泡卷藤，柔软而又舒适，令成品家具手感更佳。



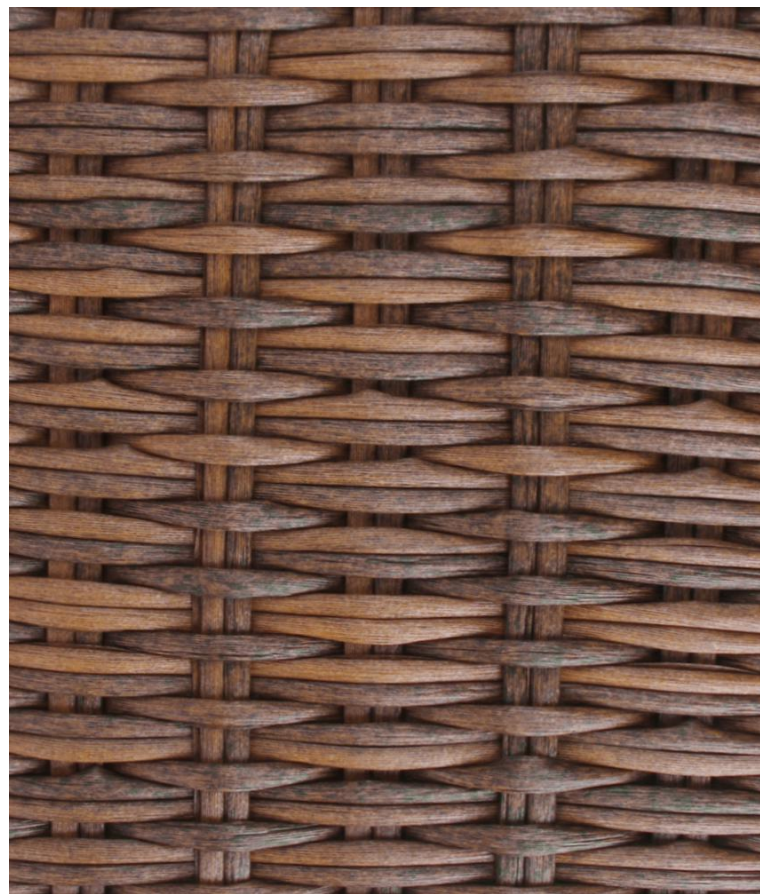

参考案例

该系列作为圆藤使用，比普通圆藤更佳轻、软，因此可塑性比普通圆藤更高。除了适用于大体量的家具，轻薄型的家具也能驾驭。

THANKS

AGO
PLASTIC RATTAN
SINCE 1999

www.china-ago.com

佛山市艺骏雄塑胶仿藤有限公司
AGO PLASTIC RATTAN CO.,LTD.
TEL:86-757-26600661/26600662
FAX:86-757-26322441

